



Techem Energimåler Ultra Radio L3 T330



Note: In the text below, the term meter refers both to the heat meter and to the cooling meter and the combined heat and cooling meter, unless otherwise specified.

1. General

1.1 Use

The T330 is used as a meter for heating or cooling consumption measurement in systems with water.

The meter consists of a volume measurement unit, two fixed temperature sensors and an electronic unit that calculates the energy consumption based on volume and temperature difference.



Note: The meter cannot be opened without damaging the security seal.

1.2 General notes

The meter left the factory in a faultless condition where safety is concerned. The manufacturer will provide additional technical support on request. Calibration relevant security seals on the meter must not be damaged or removed. Otherwise, the warranty and calibration validity of the meter will no longer apply.

- Keep the packaging so that you can transport the meter in its original packaging following expiry of the calibration validity.
- Lay all cables at a minimum distance of 500 mm to high voltage and high frequency cables.
- A relative humidity of < 93 % at 25 °C is permissible (without condensation).
- Avoid cavitation in the whole system due to overpressure i.e. at least 1 bar at qp and approx. 2 bar at qs (applies for approx. 80 °C).

2. Safety information's



The meters may only be used in building service engineering plants and only for the applications described.



The local regulations (installation etc.) must be adhered to.



The operating conditions according to the type plate must be complied with during use. Non-compliance can result in hazardous situations and the expiry of all claims arising from liability for defects as well as liability based on any expressly granted guarantees.



The meter is only suitable for circulating water in heating systems.



The meter is not suitable for drinking water.



Beware of sharp edges on thread, flange and measuring section.



Requirements for circulating water (CEN/TR 16911: 2016).



Only personnel, trained in the installation and operation of meters in heating and cooling systems, may install and remove the meter.



Only install or remove the meter when the pipes are pressure-less.



After installing the meter, check the leak-tightness of the system.



Guarantee and calibration validity will lapse if the calibration relevant security seal is broken.



Only clean the meter from outside with a soft, lightly wetted cloth. Do not use any spirit or cleaning solvent.



As far as disposal is concerned, the meter is a waste electronic appliance in the sense of European Directive 2012/19/EU (WEEE) and it must not be disposed of as domestic waste. The relevant national, legal regulations must be observed as the appliance must be disposed of via the channels provided for this purpose. The local and currently valid legislation must be observed.



The meter contains lithium batteries. Do not dispose of the meter and the batteries with domestic waste. Observe the local stipulations and laws on disposal.



You can return the lithium batteries to the manufacturer for appropriate disposal following use. When shipping please observe legal regulations, in particular, those governing the labelling and packaging of hazardous goods.



Do not open the batteries. Do not bring batteries into contact with water or expose to temperatures above 80 °C.





The meter does not have any lightning protection. Ensure lightning protection via the in-house installation.

3. Installation



To install the meter, proceed as follows:

- Determine the place of installation in line with the inscription on the meter.





Note: At a **heating meter** the mounting place of the flow sensor cold side is equivalent to return . The mounting place of the flow sensor hot side is equivalent to flow .



Note: At a **cooling meter** the mounting place of the flow sensor hot side is equivalent to the return . The mounting place of the flow sensor cold side is equivalent to flow .



Note: At a meter with an **adjustable mounting place**  L1, the mounting place hot side is displayed as *hot* . The mounting place cold side is displayed as *cold* .

- Observe the dimensions of the meter and check whether there is sufficient space available.
- Rinse the system thoroughly before installing the meter.
- Fit the meter vertically or horizontally between two slide valves so that the arrow on the housing and the flow direc-

tion match. Also observe the installation situations and the following examples of installation.

- Fit the temperature sensors in the same circuit as the meter. Please observe admixtures.
- Seal the temperature sensor and the fittings to protect against manipulation.
- If you install the meter for cooling metering, follow the appropriate notes.

Recommendation: If you are installing several meters, the same installation conditions must be consistent for all meters.

Change mounting place

Note: The mounting place is locked and can't be changed after the meter has detected a volume of 10 liters. As a result, the "P" disappears from the display:
hot 5 or cold 5

For meters with adjustable mounting place, the mounting place can be set manually. Proceed as follows:

- Hold the button several times long (for more than 3 s) until *LOOP 1* appears on the LCD.
- Press the button briefly repeatedly until *P hot 5* or *P cold 5* appears on the LCD.
- To change the mounting place, press the button longer (more than 3 sec). The LCD display changes. The change happens automatically. The mounting place is locked and can't be changed after the meter has detected a volume of 10 liters.
- Adjust the temperature sensors according to the installation requirements.

Installation notes

Note: When installing the meter, the locally applicable installation regulations for meters must be observed.

Inlet or outlet sections are not necessary. If you install the meter in the common return of two circuits, determine a place of installation with a minimum distance of $10 \times DN$ from the T-piece. This distance ensures a good mixing of the different water temperatures. You can install the temperature sensors in T-pieces, ball valves, directly immersed or in pockets depending on the version. The temperature sensor ends must reach to at least the middle of the pipe cross section.

Note: Protect the meter against damage through impacts or vibrations at the place of installation.

Note: Ensure the electronic unit is protected against any ingress of water.

Recommendation: Do not install the meter on the intake side of a pump. Maintain a minimum distance of $10 \times DN$ on the outlet side.

Examples of installation (directly immersed sensor)

You can install the meter in any position e.g., vertically, or horizontally. In order to avoid accumulation of air and disruption in operation, fit the meter in a vertical installation position and not in the uppermost area of a pipeline.

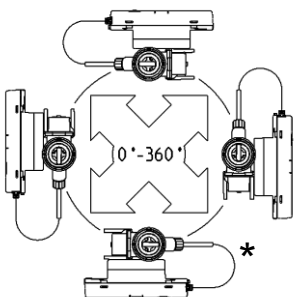

* This position is not permitted for cold meters and in cases where moisture can enter the electronic unit due to condensation (e.g., during an interruption in the summer).

Fig. 1

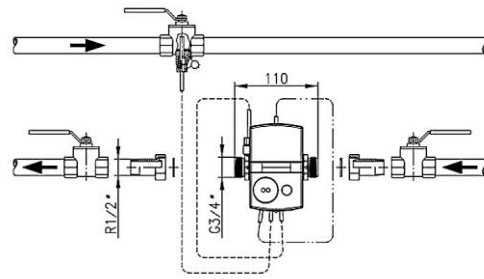

Fig. 2: Example for installation with ball valve and meter with 110 mm armature

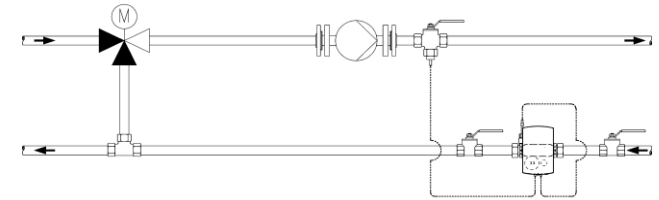

Fig. 3: Installation for circulation with admixing; placement of temperature sensors

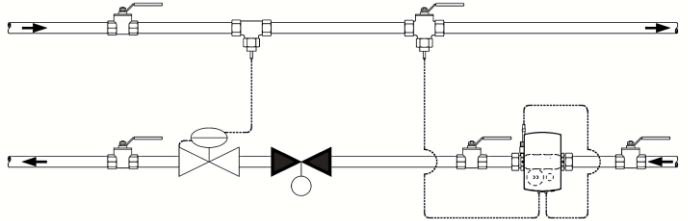

Fig. 4: Installation for circulation with throttling configuration for example (flow sensor in flow direction before control valve / differential pressure regulating valve)

Installation notes for sensor adapter set

A mounting set is included for meters with 5.2×45 mm temperature sensors. With this you can fit the temperature sensor directly immersed into an insert or a ball valve for example.

1. Use the fit-up aid/pen provided to mount the O-ring at the installation point.
2. Place both halves of the plastic bolting round the 3 notches of the temperature sensor.
3. Press the bolting together and screw the bolting hand tight into the installation point up to the stop (tightening torque 3 ... 5 Nm).

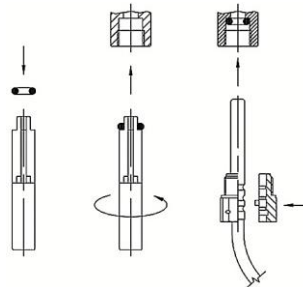

Fig. 5: Mounting adapter set

3.1 Installation of cooling meters and combined heat/cooling meters

Observe the following installation instructions to avoid condensation water.

- Mount the cooling meter so that the black cover on the measuring section points sideways or downwards.
- Mount the electronic unit separated from the volume measuring unit e. g. on the wall.
- Form a loop downwards with the connected cables.
- Mount the protection pocket so that the temperature sensor stands vertically downwards or horizontally.
- Mount the temperature sensor horizontal or vertical in the pipe from below.

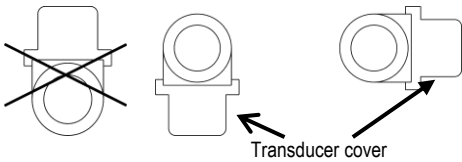

Fig. 6: Recommended mounting position for cooling measurement

3.2 Electronic unit

The ambient temperature of the electronic unit must not exceed 55 °C. Avoid direct sunlight. Mount the electronic unit separated from the volume measurement unit e. g. on the wall if the water temperatures are below 10 °C and above 90 °C.

Aligning electronic unit

Proceed as follows to align the electronic unit:

- Turn the electronic unit to the left or right through 90° or through 180° as required.

Note: When turning through 45° the electronic unit is not connected tightly to the volume measurement unit.

Wall fitting (split fitting)

Proceed as follows for the wall fitting:

- Turn the electronic unit through 45°.
- Pull the electronic unit away from the volume measurement unit.
- Unscrew the adapter plate from the volume measuring unit.
- Fix the adapter plate on the wall.

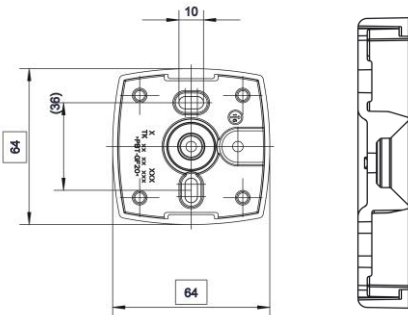

Fig. 7: Top view and cross section of the adapter plate

- Place the electronic unit on the wall adapter at an angle of 45° and turn it into position.

3.3 Power supply

The meter is equipped with a long-life battery for 6 or 11 years of operation. You can find the operating time on the dial plate.



Warning: Do not open the batteries. Do not bring battery into contact with water or expose to temperatures above 80 °C. Dispose of used batteries at suitable collection points.

3.4 Interfaces and Communication

Note: Frequently switching off the M-bus voltage may result in a reduction of the battery life.

The meter is equipped with an optical interface in accordance with EN 62056-21 as standard.

If the meter is equipped with the option "M-Bus", it is supplied with a 2-wire cable.

If the meter is equipped with the option "pulse", it is supplied with a 4-wire cable.

The connection cable can be extended by fitting a junction box.

3.5 Temperature sensor



Note: Wires must not be separated, shortened, or extended.

4. Operating



Note: Both display range and data displayed can differ from this description depending on the appliance parameterization. Certain button functions can also be blocked.

The meter consists of a 7-digit LCD displaying various values.

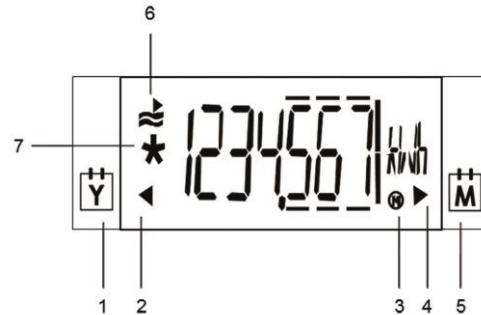

Fig. 8: LCD

Number	Description
1	Identification previous year value
2	Previous year value
3	Maxima
4	Previous month value
5	Identification previous month value
6	Activity display at flow
7	Calibrated value

Switching the display

Proceed as follows to switch between the display values:

- Press the button briefly (for less than 2 sec.) to show the next line of the current loop.

After the last line is displayed, the first line comes up again.

- Hold down the button (longer than 3 sec.) in order to display the next loop.

After the last loop is displayed, the first loop comes up again.

If you do not operate the meter for 30 sec. in the user loop "LOOP 0", the meter changes to the standard display. If you do not operate the meter for 30 min. in the loops "LOOP 1 ... 4", the meter changes to the standard display.

User loop "LOOP 0"

LOOP 0	User loop	*0000000	Segment test
*1234567 kWh	Energy quantity	F:...	In case of error message with error code
1234567 kWh	Cooling registers (optional)		
cold			
*1234567 m³	Volume		

Current values "LOOP 1"

LOOP 1	Current value		
1234 kWh	Current flow	P hot 5	Mounting place here: hot side, changeable; optional)
300 kWh	Current heat power	bd 1234 h	Operating time with flow
670 °C	Alternate current temperature hot and cold side in 2 s cycles	Fd 123 h	Operating time with flow
460 °C		Pd 1234 h	Time with flow
210 K	Temperature difference		

Previous month's values "LOOP 2"

LOOP 2	Previous month's values	
0102.12 ^M	Log date	1000 ^M
1234567 ^M	Amount of energy at the reporting date	1702.12 ^M
1234567 ^M	Cooling registers at the reporting date (optional)	810 ^M
cold		1702.12 ^M
1234567 ^M	Volume at the reporting date	660 ^M
Fd 123	Missing time on set day	1702.12 ^M
3099 ^M	Max. flow on set day in 2 s cycles with date stamp	
1702.12 ^M		

General/Communication "LOOP 3"

LOOP 3	General/Communication	
1234567 ^G	Device number, 7-digit	0101--
Mbus	Optional interface	01---M
127 ^A	Primary address (only for M-Bus)	17-16 ^M
0000000 ^A	Secondary address 7-digit - for M-Bus	CC7E05
		Yearly set day
		Monthly set day
		Firmware version
		CRC-Code

Other "LOOP 4"

LOOP 4	Other	
0002.12 ^D	Date	----
105959 ^T	Time	Code entry for test / para operation

4.1 Monthly values

The meter stores the following values for 24 months on the monthly set day

- Missing time
 - Volume
 - Energy
- and the maxima with date stamp for
- Flow
 - Power
 - Temperature hot side
 - Temperature cold side

4.2 Parameterization

When the LCD displays the code input, you can access the parameterization operation by entering the code. You can set date and M-Bus primary address in the parameterization operation for example. For more detail see the separate parameterization instruction.

5. Getting started

For activation proceed as follows:

- Open the slide valves slowly.
- Check the heating system for leak-tightness.
- Vent the heating system carefully.
- Press the button on the meter briefly.

The message "F0" disappears after 10 sec.

- Check the measured values for flow and temperatures for plausibility.

- If needed vent the heating system until the flow display is stable.
- Fit the user locks to the fittings and the temperature sensors. The scope of supply includes two self-lock seals for sealing a sensor and the connecting fitting.
- Read the meter status for energy, volume, operation, and missing time and note the values.

Error messages for incorrect installation:

FL nEE	Error "incorrect flow direction (negative)" Check that the flow direction arrows on the volume measurement unit match the flow direction of the system. If the directions do not match, turn the volume measurement unit by 180°.
d iFFnEE	Error "negative temperature difference" Check whether the sensors are installed in the right circular flow (flow and return flow interchanged). Use only a meter suitable to the mounting place. Heat meter: Temperature sensor in the flow-pipe with higher temperatures; temperature sensor in return-pipe with lower temperature Cooling meter: Temperature sensor in the flow-pipe with lower temperatures; temperature sensor in return-pipe with higher temperature

6. Functional details

If the respective operation thresholds are exceeded and flow and temperature difference are positive, the meter summates the energy and the volume.

If the operate margin is gone below a "u" is displayed at a leading point for the flow, power and temperature display.

For a positive flow the activity display  appears in the user loop in the LCD.

All segments of the display are switched on for control purposes during the segment test. The flow, power and temperature difference are recorded with the appropriate +/- signs.

The operating hours are counted from the first connection of the power supply. The meter saves "operating time with flow" as soon as a positive flow is recognized. Missing hours are summated if there is a fault and the meter is thus unable to take a measurement.

Stored maximum values are marked with an „“ in the lower right-hand area of the LCD.

7. Error codes

The meter continuously runs a self-diagnosis and can thus recognize and display various installation or meter errors:

Error code	Error	Service guidelines
FL nEG	Incorrect flow direction	Check flow or installation direction; correct if necessary
if necessary, in exchange with:		
DIFF nEG	Negative temperature difference	Check installation point of the temperature sensors; exchange if necessary
if necessary, in exchange with:		
F0	No flow can be measured	Air in the measurement unit/pipe, bleed air from pipe (delivery condition)
F1	Interruption in the hot side temperature sensor	Inform service department
F2	Interruption in cold side temperature sensor	Inform service department
F3	Electronics for temperature evaluation defective	Inform service department
F4	Battery flat	Inform service department
F5	Short-circuit hot side temperature sensor	Inform service department
F6	Short-circuit cold side temperature sensor	Inform service department
F7	Error in the internal memory holding	Inform service department
F8	Errors F1, F2, F3, F5 or F6 for longer than 8 hours, recognition of attempts to manipulate.	Measure dependent on error code. Error message F8 must be reset by service department.
F9	Error in the electronics	Inform service department

8. Technical data

 **Note:** The information on the meter must be observed!

General

Measuring accuracy	Class 2 or 3 (EN 1434)
Environment class	A (EN 1434) for indoor installation
Mechanical class	M1 / M2 *)
Electromagnetic class	E1 *)
*) according to 2014/32/EU Directive on Measuring Instruments	
Ambient humidity	< 93% rel. humidity at 25 °C, without condensation
Max. height	2000 m above sea level
Storage temperature	- 20 ... 60 °C

Electronic unit

Ambient temperature	5 ... 55 °C
Housing protection rating	IP 54 according to EN 60529
Power supply	Battery for 6, 11 or 12 years
Operation threshold f. ΔT	0.2 K
Temperature difference ΔT	3 K ... 80 K
Temperature measurement range	0 ... 180 °C
LCD	7 digits
Optical interface	Standard, EN 62056-21
Communication	Optional
Separability	Always, cable length 1.5 m

Temperature sensor

Type	Pt 500 according to EN 60751, not detachable
Connection type	Pt 500, 2 wire technology
Cable length	1.5, 3, 5 m
Construction type	Bolb sensor ø 5,2 × 45 mm; DS direct short, M10 × 27.5 mm
Temperature range	0 ... 105 °C, 0 ... 150 °C

Volume measuring unit

Protection class	IP 54 according to EN 60529; optional IP 65 / IP 68
Mounting place	Hot side / cold side
Installation position	Any, horizontal or vertical
Flow straightening	None
Measuring range	1:100
Temperature range	5 ... 105 °C; 5...130 °C National type approvals may be different.
Maximum overload	qs = 2 x qp, permanent
Nominal pressure	PN16 (1.6 MPa; PS16)

PN25 (2.5 MPa; PS25)

Power supply

Type of power supply	Battery for 6, 11 or 12 years
Battery type	AA cell lithium
Lithium content	0.65 g per battery
Number of batteries	1 – 3, depending on the configuration

qp m³/h Overall length and connection

0.6	110 mm (3/4 ")		190 mm (1 ")
1.5	110 mm (3/4 ")	130 mm (1 ")	190 mm (1 ")
2.5		130 mm (1 ")	190 mm (1 ")
3.5			260 mm (1 ¼ ")
6			150 mm (1 ¼ ") 260 mm (1 ¼ ")

EC Declaration of Conformity

No. CE T330 003 / 03.19



Product description: Ultrasonic heating meter
 ULTRAHEAT®T330 (UH30...)
 Manufacturer: Landis+Gyr GmbH, Humboldtstrasse 64, 90459
 Nuremberg, Germany

Landis+Gyr GmbH takes sole responsibility for the issue of this declaration of conformity. It declares herewith that the above named product meets the requirements of the following directives and laws:

2014/32/EU (MID) OJ L 96 29/03/2014
2011/65/EU (RoHS) OJ L 174 01/07/2011
2014/53/EU (RED) OJ L 153 22/05/2014

These respective harmonised standards and normative documents were taken as a basis:

Standard	Last revised	Directive	Reference	Standard	Last revised	Directive	Reference
EN 61000-6-3	2011	RED	OJ C 053 25/02/2014	EN 50581	2012	RoHS	OJ C 363 23/11/2012
EN 62368-1	2015	RED	OJ C 326 14/09/2018	EN 1434-4	2007	MID	OJ C 218 24/07/2012
EN 300 220-1	2017 ⁶⁶⁸	RED		EN 1434-5	2007	MID	OJ C 218 24/07/2012
EN 300 220-2	2017 ⁶⁶⁸	RED	OJ C 76 10/03/2017	EN 1434-4	2015	MID	
EN 301 489-1	2017 ⁶⁶⁸	RED		EN 1434-5	2015	MID	
EN 301 489-3	2017 ⁶⁶⁸	RED					

Environmental class for MID and EMC E1 or A

⁶⁶⁸ Applies to wireless M-Bus modul 868 MHz

The notified authority (PTB, 0102) has tested the technical design and certified that it meets the requirements applicable for the device and has issued the following certificate: DE-17-MI004-PTB005 and DE-17-MI004-PTB006

The notified authority (PTB, 0102) has evaluated the quality assurance system and recognises it in: DE-M-AQ-PTB006

Nuremberg, 07/03/2019

Brunner, VP CoC HEAT
 Name, Position Signature

Dr. Rother, Head R&D
 Name, Position Signature

This declaration certifies conformity with the stated directives and standards, it does not however constitute a commitment to any specific properties!
 The safety instructions included in the product documentation must be followed!